

DUOMO

PICCOLO WALL SCONCE

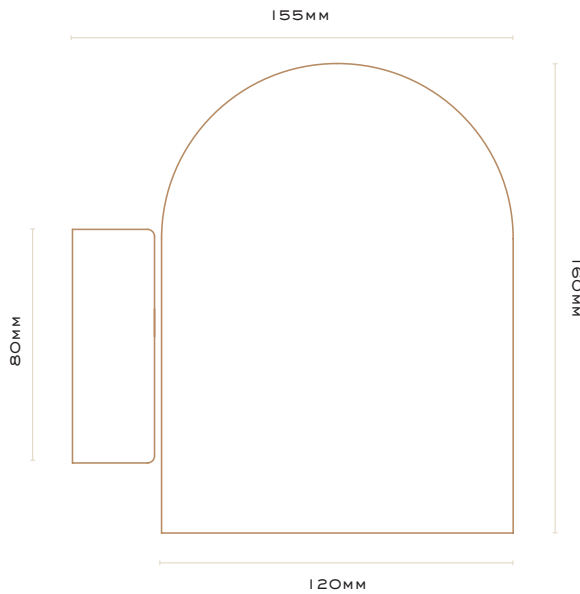



DUOMO PICCOLO WALL SCONCE



COLOURS:

Natural Brass
Whiskey Brass
Midnight Brass
Matte White

COLOUR TEMPERATURE

Warm White 2700K



LEAD TIME:

Up to 6 weeks



LIGHT FITTING:

WATTAGE:

6W

IP RATING:

IP65 - Suitable for exterior and wet area use

REMOTE DRIVER (INCLUDED):

TCI Mini Jolly (size: 102mm x 38mm x 21mm)

Allow room in wall cavity or a distance up to 10m from fitting

DIMMING OPTIONS:

1-10V, Non-dim, Push (DALI available on request)

All fixtures must be installed by a licensed electrician. Please also consult a licensed electrician for any electrical, dimming and wiring enquiries.

DUOMO

PICCOLO WALL SCONCE

(220V-240V / E27)



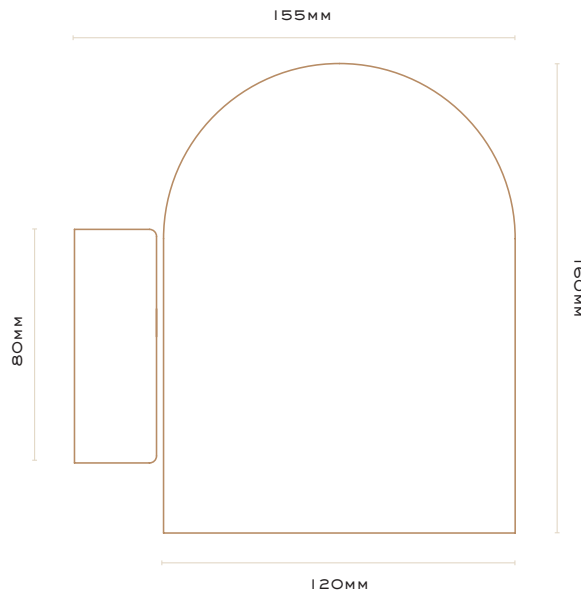

DUOMO PICCOLO WALL SCONCE (220V-240V / E27)



COLOURS:

Natural Brass
Whiskey Brass
Midnight Brass
Matte White



LIGHT FITTING:

E27 light fitting (globe not included)

WATTAGE:

Max 40W

IP RATING:

IP20



LEAD TIME:

Up to 6 weeks

DIMMING OPTIONS:

Non-dim, Dimmable (dimmable globe required)

All fixtures must be installed by a licensed electrician. Please also consult a licensed electrician for any electrical, dimming and wiring enquiries.



DUOMO PICCOLO WALL SCONCE 220-240V (E27)(IP20)

PRODUCT CODE: E27DPSCBR / E27DPSC-WHITE

Installation guide

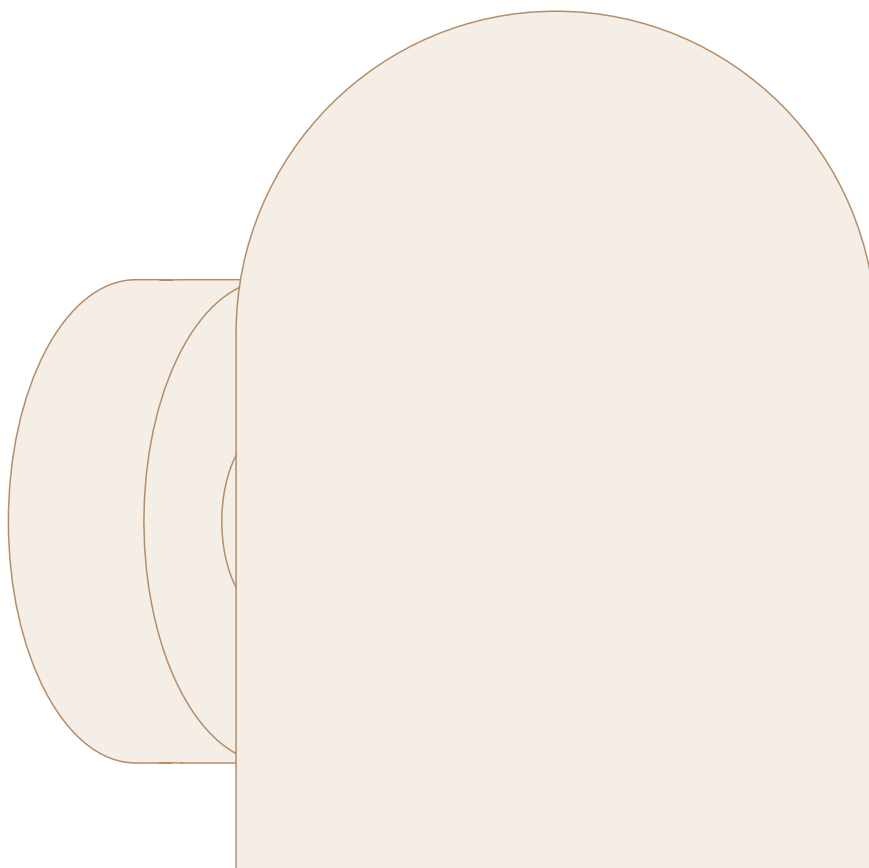

DANGER electric shock risk. Installation must be conducted by a licensed electrician.

DUOMO PICCOLO WALL SCONCE

Installation guide



DANGER electric shock risk. Installation must be conducted by a licensed electrician.

STAGE 1: WIRE FITTING

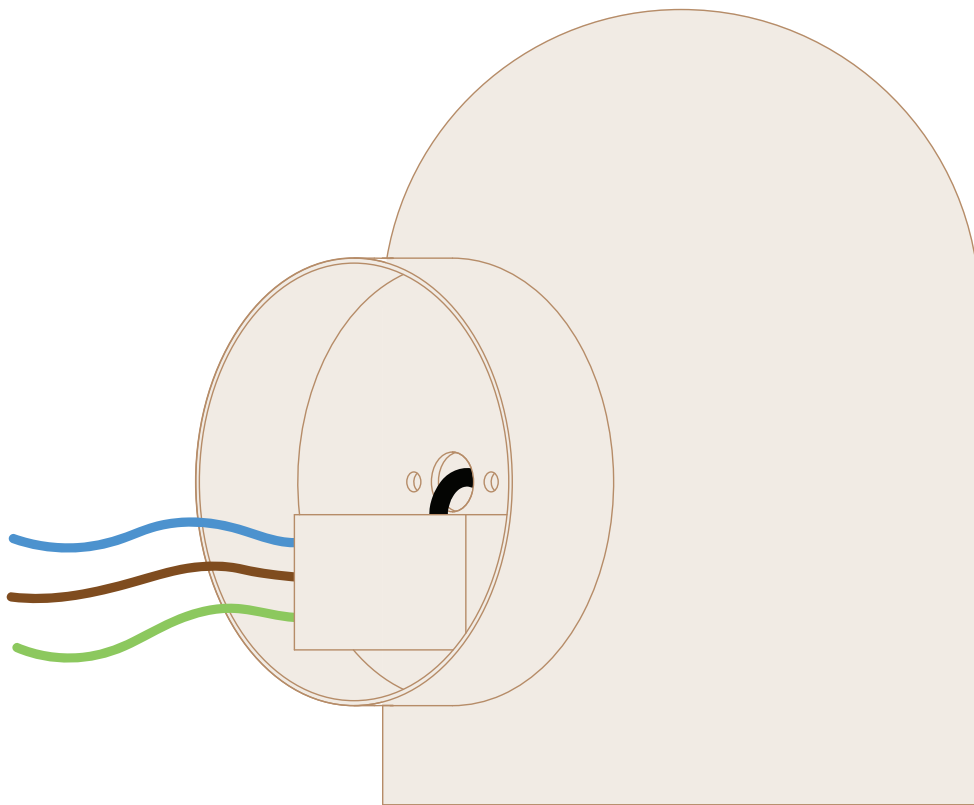

E27 fitting (bulb not provided)





DANGER electric shock risk. Installation must be conducted by a licensed electrician.

STAGE 2: INSTALL FITTING

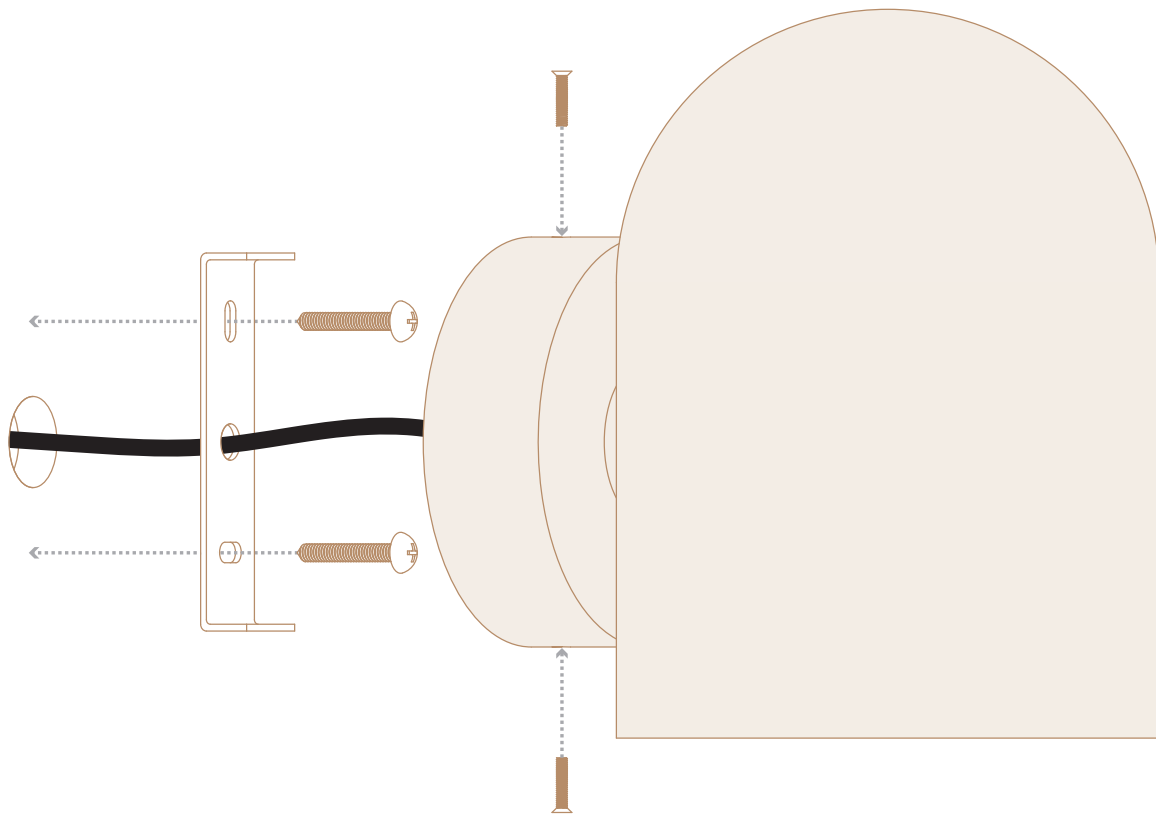

Ensure gloves are worn when handling natural brass products.

- 1: Remove all items from box.
- 2: Using HEX key provided, remove M3 brass screws from top and bottom of fitting.
- 3: *(Optional)* If installing to plaster board pre-drill and install wall plugs into wall.
- 4: Install wall plate to wall using timber screws provided.
- 5: Wire fitting as shown on opposite page.
- 6: Install fitting onto wall bracket and secure M3 brass screws to top and bottom of fitting.
- 7: Wipe down fitting with clean dry cloth.
- 8: Install E27 light bulb. (not provided)
- 9: Test fitting.



DUOMO PICCOLO WALL SCONCE (IP65)

PRODUCT CODE: DPSCBR / DPSCWH

Installation guide

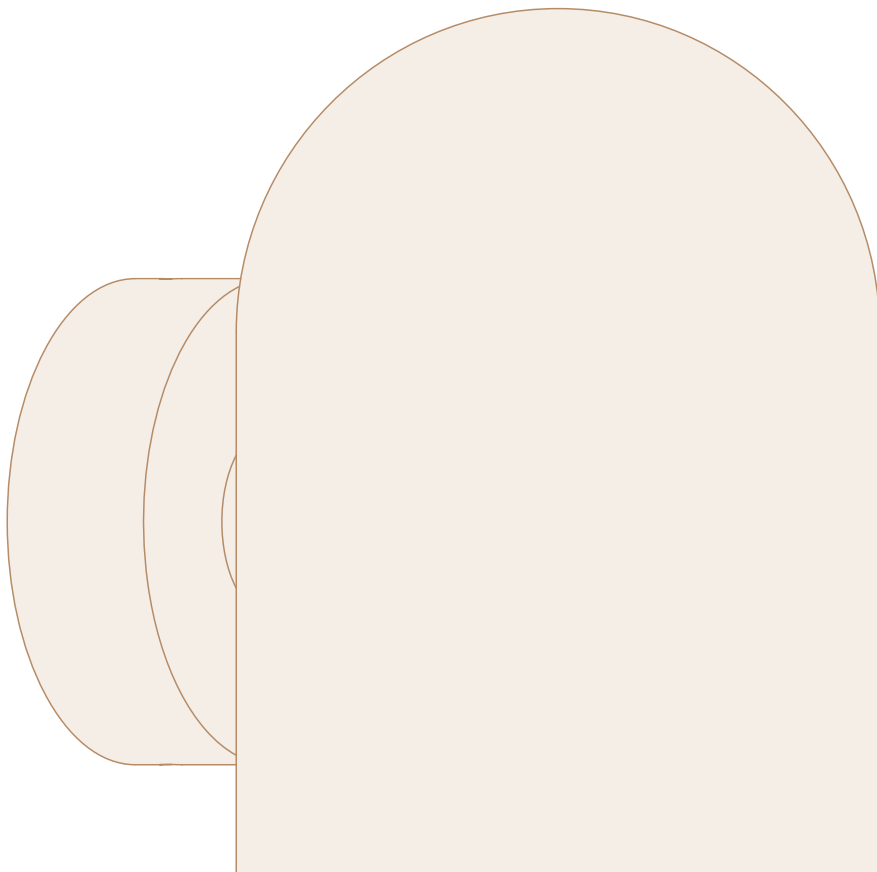

12V - Do not wire light fitting directly to mains power.

DUOMO PICCOLO WALL SCONCE

Installation guide



DANGER electric shock risk. Installation must be conducted by a licensed electrician.

STAGE 1: INSTALL DRIVER

TCI Mini Jolly 125400

12V Constant Voltage

Minimum cut-out hole diameter: 55 mm

Size: 111 x 22 x 52 mm

Plastic case: IP20 rated

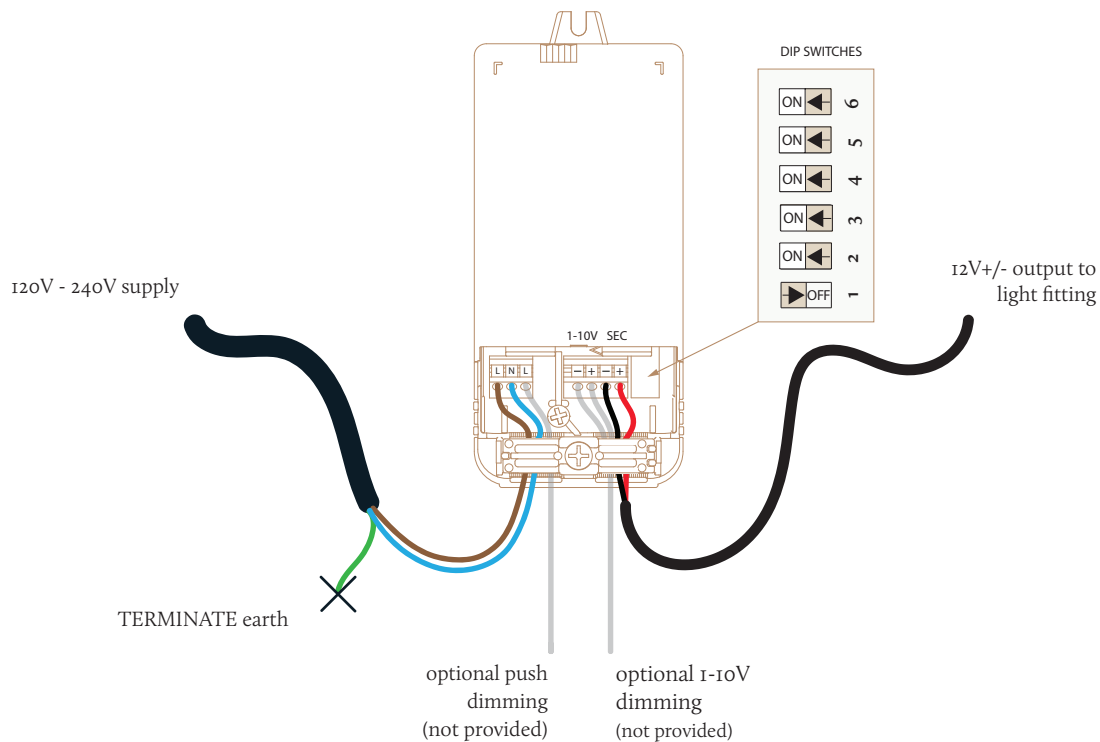

- 1: Select driver location, ideally a remote location that is accessible such as an attic or cupboard. Affix driver to solid surface.
- 2: Unscrew terminal cover and unclick from sides.
- 3: Check DIP switches are set to required position - if not, set to pattern as shown above using a small screwdriver.
- 4: Ensure mains supply is switched off. Connect 120V-240V Load and Neutral supply to the left side of the driver as shown.
- 5: Terminate earth if present.
- 6: *Option A:* While at the framing stage, run a 2x core cable from the SEC output on the driver, to the desired position of the luminaire.
Option B: If the driver must be located behind the luminaire. Connect +/- from LED luminaire to right side of driver in the SEC output.
- 7: (*Optional, not supplied*) If dimming is required, connect leads for 1-10V or Push Dimmer as illustrated.
- 8: Reattach terminal cover and screw closed.



12V - Do not wire light fitting directly to mains power.

STAGE 2: INSTALL FITTING

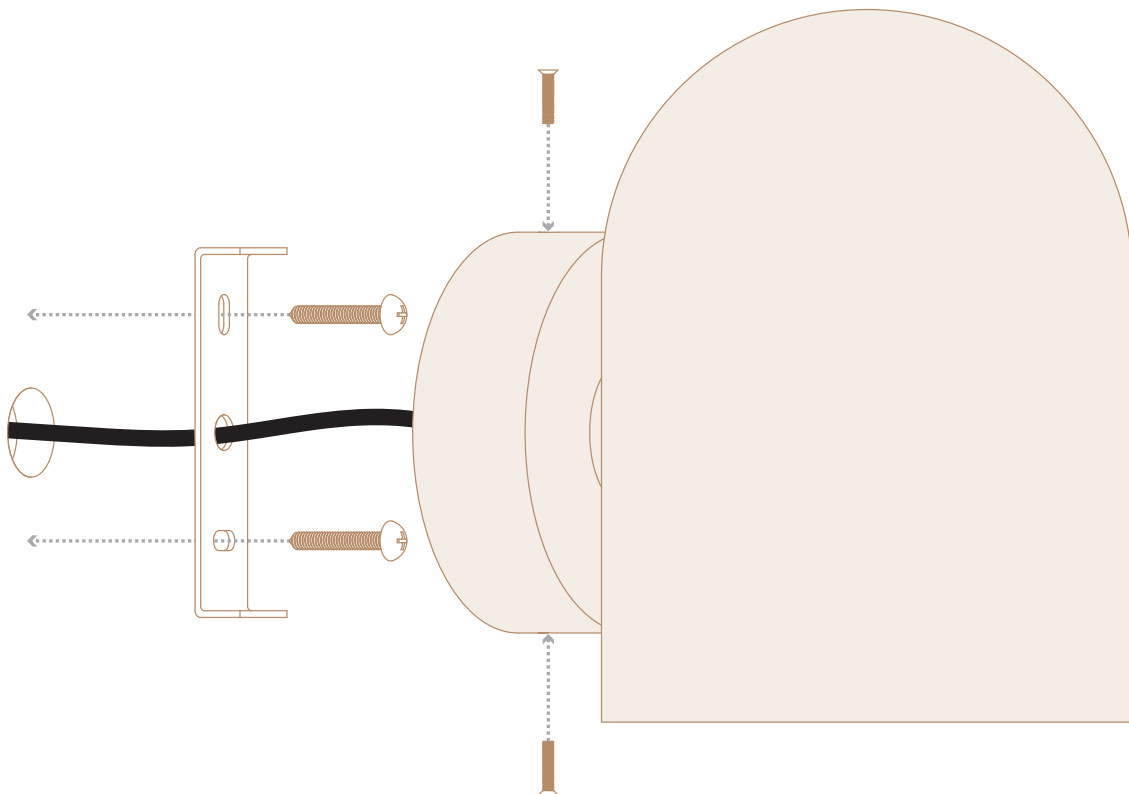

Ensure gloves are worn when handling natural brass products.

- 1: Remove all items from box.
- 2: Install driver as shown on opposite page.
- 3: Using HEX key provided, remove M3 brass screws from top and bottom of fitting.
- 4: *(Optional)* If installing to plaster board pre-drill and install white wall plugs into wall.
- 5: Install white wall plate to wall using timber screws provided.
- 6: Connect +/- power supply from LED luminaire to TCI Mini Jolly driver.
- 7: Install fitting onto wall bracket and secure M3 brass screws to top and bottom of fitting.
- 8: Wipe down fitting with clean dry cloth.
- 9: Test fitting.