

D700.PLUS.RSX SHARP Curve LED Downlight

Datasheet



TRU-COLOUR.

Product Codes

Unit: D700.PLUS.RSX	Series: CR	Colour temp. (K): 1.8K.3K (1800K-3000K) (Nightshift) [Dim to warm] (Special Order) 2.7K (2700K) (Special Order) 3K (3000K) 4K (4000K) (Special Order) 5K (5000K) (Special Order)	Beam Angle (°): 36 (36°) 50 (50°)	Luminaire Colour: B (BLACK) W (WHITE)	Control: PH (Phase Dimming)
Inner Colour: B (BLACK) W (WHITE) RALXXXX (Custom Colour)	Style: SHARP	Style Colour: B (BLACK) W (WHITE) RALXXXX (Custom Colour)	Generation: 4.0		

Dimensions (mm)

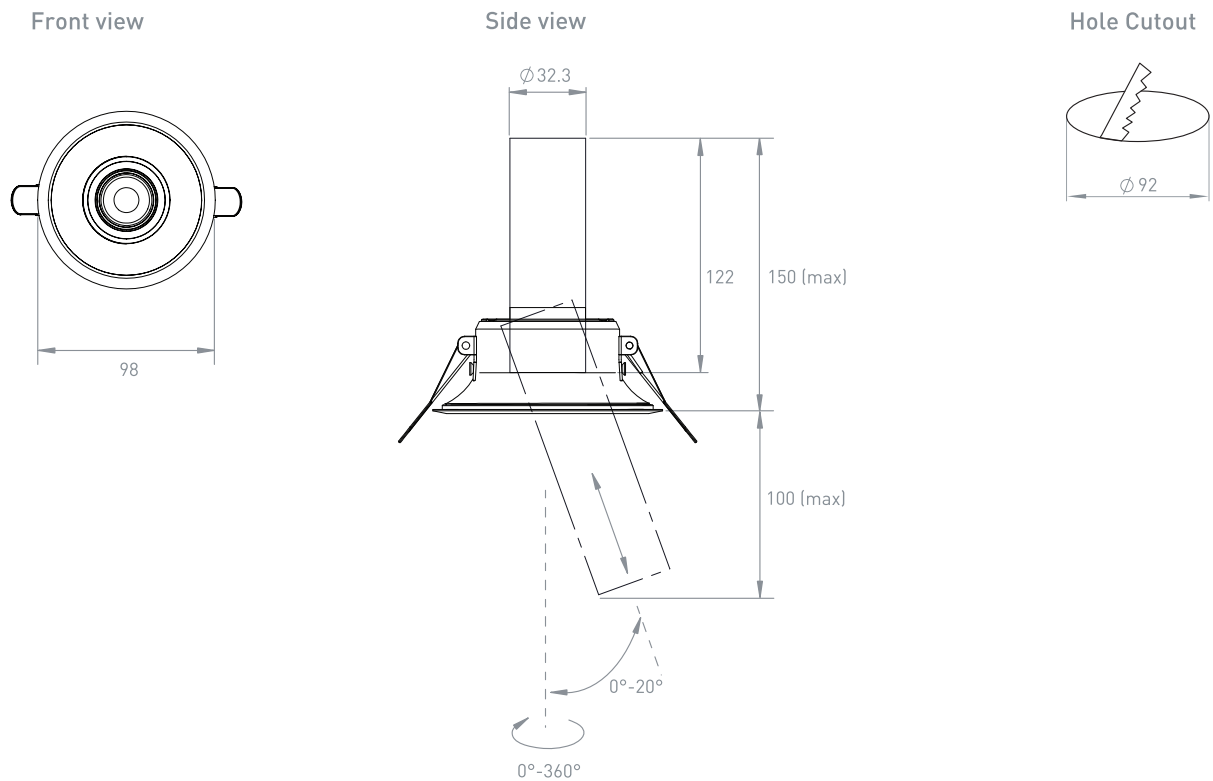

Photometrics

Photometric Diagram

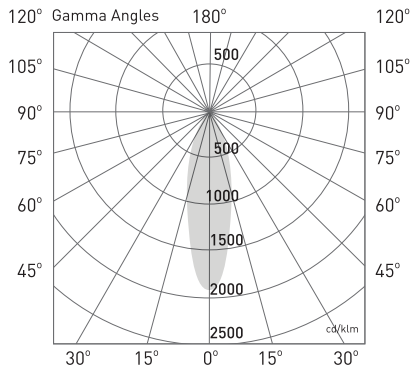

Beam Angle: 36°

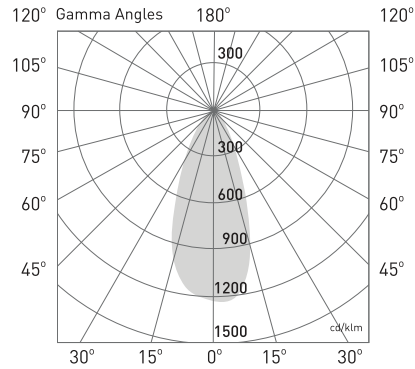

Beam Angle: 50°

CCT Output

CCT: 1800K-3100K
Efficacy: 71lm/W
Delivered lumen output: 640lm
CRI: 98
Standard deviation of colour Matching (SDCM): 3 MacAdam steps

CCT: 2700K
Efficacy: 70lm/W
Delivered lumen output: 630lm
CRI: 98
Standard deviation of colour Matching (SDCM): 3 MacAdam steps

CCT: 3000K
Efficacy: 71lm/W
Delivered lumen output: 640lm
CRI: 98
Standard deviation of colour Matching (SDCM): 3 MacAdam steps

CCT: 4000K
Efficacy: 73lm/W
Delivered lumen output: 655lm
CRI: 98
Standard deviation of colour Matching (SDCM): 3 MacAdam steps

CCT: 5000K
Efficacy: 79lm/W
Delivered lumen output: 710lm
CRI: 98
Standard deviation of colour Matching (SDCM): 3 MacAdam steps

Electrical

Input Voltage: 220-265V **Power Usage:** 9W **Current:** 240mA **Driver Power Factor:** >0.9 **Dimming:** Yes

Physical

Gimbal Angle (°): 20°/360° **IP Rating:** IP44 **IK Rating:** IK04

Operational

Ambient temp.: -20°C to 50°C **IC Rating:** IC-4 **UGR:** <19 (36° Lens, X=4H, Y=8H) **Lifetime L70, B10:** 70,000hrs (@TA85) **Lifetime L70, B50:** 100,000hrs (@TA25) **Warranty:** 7 Years **STC Rating:** 42

Installation

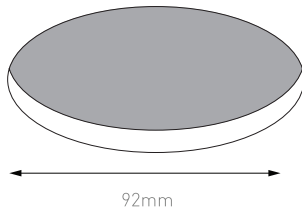

Step 1

Using a 92mm hole saw, cut a hole in the ceiling at the desired location.

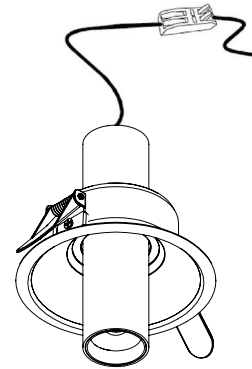

Step 2

Connect the 240V power cable to the terminal block.

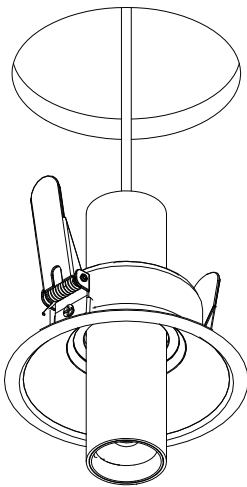

Step 3

Pull back the springs and insert the luminaire into the ceiling cavity.

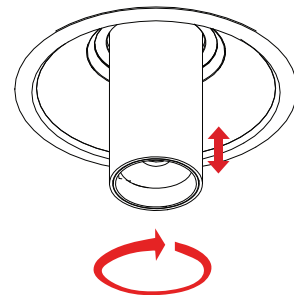

Step 4

Once the light is installed, orient the luminaire using its gimbal to focus the light as required.