

W900.SIP Curve LED Wall Light Datasheet



TRU-COLOUR®

Product codes

Unit: W900.SIP	Series: CR	Colour temp.: 3K (3000K)	Beam angle (°): 360 (360°)	Colour: W (White) B (Black)	Driver: PHASE (PHASE)	Version: 1.0
--------------------------	----------------------	------------------------------------	--------------------------------------	--	---------------------------------	------------------------

Dimensions (mm)

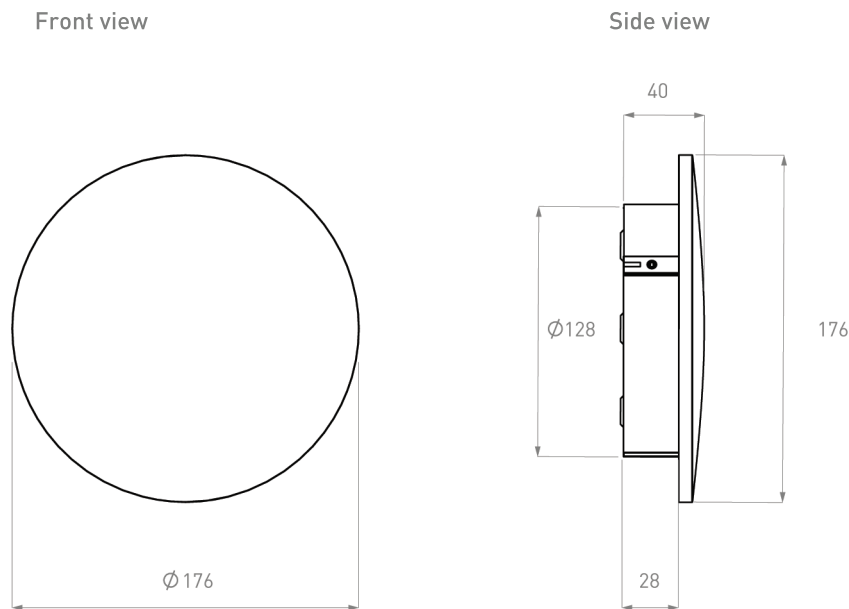

Photometrics

Source lumen output: 975lm
Delivered lumen: 780lm
Efficacy: 65lm/W
Colour temp.: 3000K
Beam angle: 360°
CRI: >98
Standard deviation of colour matching (SDCM): 3 Macadam steps

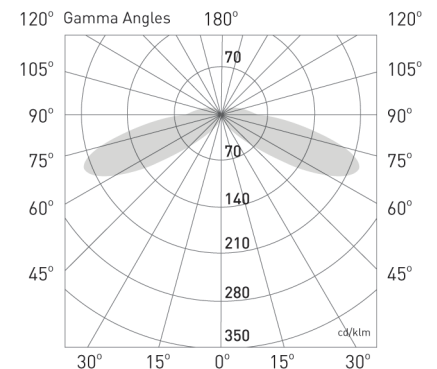

Electrical

Input voltage:
230V

Power usage:
12W

Driver power factor:
0.9

IP rating:
IP65

Dimmable:
Yes

Operational

Ambient Temp.:
-20°C to 45°C

Lifetime:
40,000 hrs

SDCM:
3MacAdam Steps

Physical

Warranty:
5 years

Mounting type:
Surface

Installation

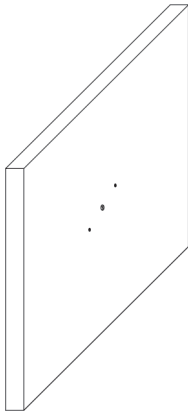

Step 1

Mark and drill the holes for the wall plugs at the desired location.

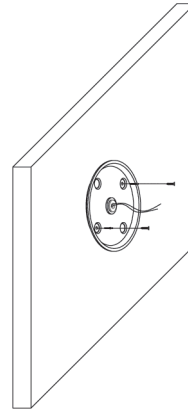

Step 2

Insert the wall plugs and fasten the base plate to the wall using the screws provided.

Installation

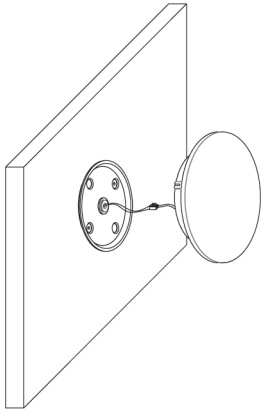

Step 3

Connect the mainspower cable to the terminal block.

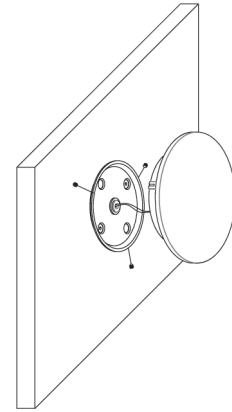

Step 4

Position the luminaire back to the base plate and secure with the grub screws.

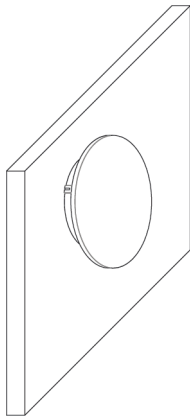

Step 5

Installation complete.