

# D700.SHX.MINI Curve LED Surface Mounted Downlight

## Datasheet



**TRU-COLOUR.**

### Product Codes

Unit:	Series:	Colour temp. (K):	Beam Angle:	Body Color:	Control:	Version:
D700.SHX.MINI	CR	2.7K (2700K) (Special Order) 3K (3000K) 4K (4000K) (Special Order) 5K (5000K) (Special Order)	15° (Special Order) 36° 50° (Special Order)	B (BLACK) W (WHITE)	PHASE (PHASE)	1.0
D700.SHX.MINI	CR	1.8K.3.1K (1800K-3100K) (Nightshift Dim to Warm) (Special Order)	15° (Special Order) 36° 50° (Special Order)	B (BLACK) W (WHITE)	PHASE (PHASE)	1.1

### Dimensions (mm)

Front view



Side view

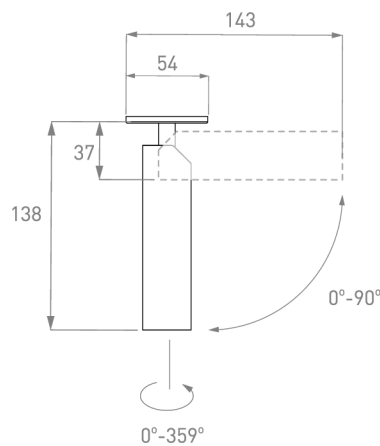

Hole Cutout



### Photometrics

#### Photometric Diagram

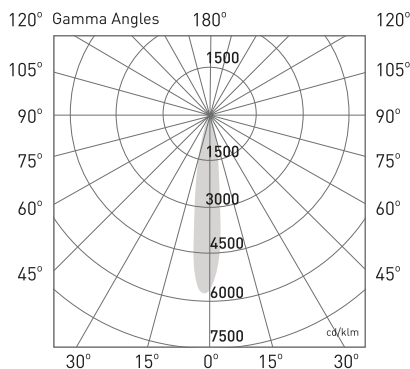

Beam Angle: 15°

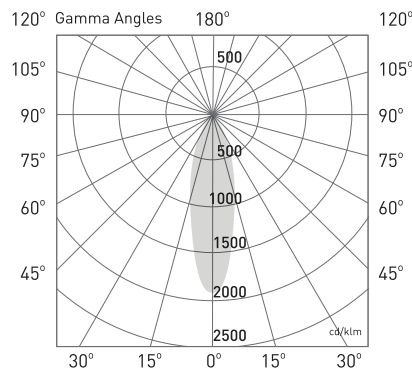

Beam Angle: 36°

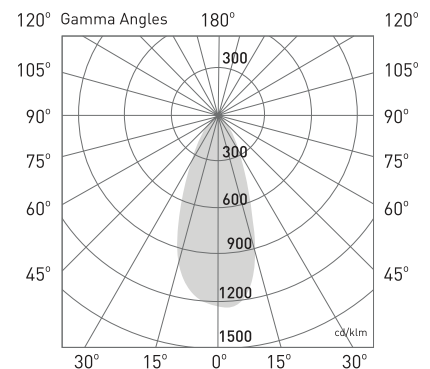

Beam Angle: 50°

## CCT Outputs

**CCT:** 1800K-3100K  
**Efficacy:** 71lm/W  
**Delivered lumen output:** 640lm  
**CRI:** 98  
**Standard deviation of colour**  
**Matching (SDCM):** 3 MacAdam steps

**CCT:** 2700K  
**Efficacy:** 70lm/W  
**Delivered lumen output:** 630lm  
**CRI:** 98  
**Standard deviation of colour**  
**Matching (SDCM):** 3 MacAdam steps

**CCT:** 3000K  
**Efficacy:** 71lm/W  
**Delivered lumen output:** 640lm  
**CRI:** 98  
**Standard deviation of colour**  
**Matching (SDCM):** 3 MacAdam steps

**CCT:** 4000K  
**Efficacy:** 73lm/W  
**Delivered lumen output:** 655lm  
**CRI:** 98  
**Standard deviation of colour**  
**Matching (SDCM):** 3 MacAdam steps

**CCT:** 5000K  
**Efficacy:** 79lm/W  
**Delivered lumen output:** 710lm  
**CRI:** 98  
**Standard deviation of colour**  
**Matching (SDCM):** 3 MacAdam steps

## Electrical

**Input Voltage:**  
220V-265V

**Power Usage:**  
9W

**Driver Power Factor:**  
>0.9

**IP Rating:**  
IP44

## Operational

**Ambient Temp.:**  
-20°C to 50°C

**Warranty:**  
7 Years

**Lifetime L70, B10:**  
70,000hrs

## Installation

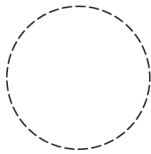

### Step 1

Cut a 20mm hole in the ceiling

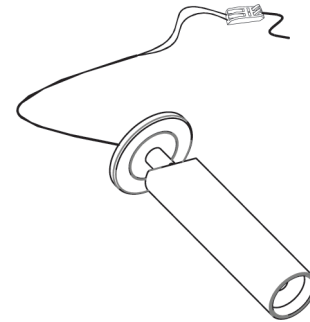

### Step 2

Thread the 240V AC power cable through the hole and connect it to the terminal block.

## Installation

---

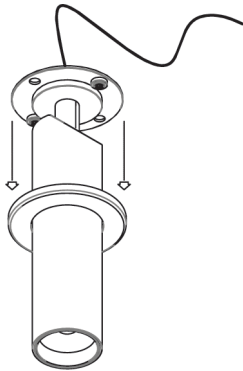

### Step 3

Slide the face plate off the ceiling rose to expose the screw mount holes.



### Step 4

Fasten the light to the ceiling using the mounting screws provided.

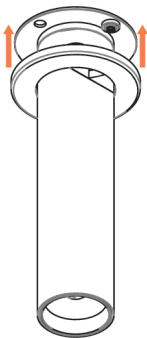

### Step 5

Slide the cover back to cover the ceiling mount.

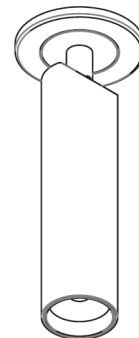

### Step 6

Installation complete.